

STC RATING: 45 MINIMUM

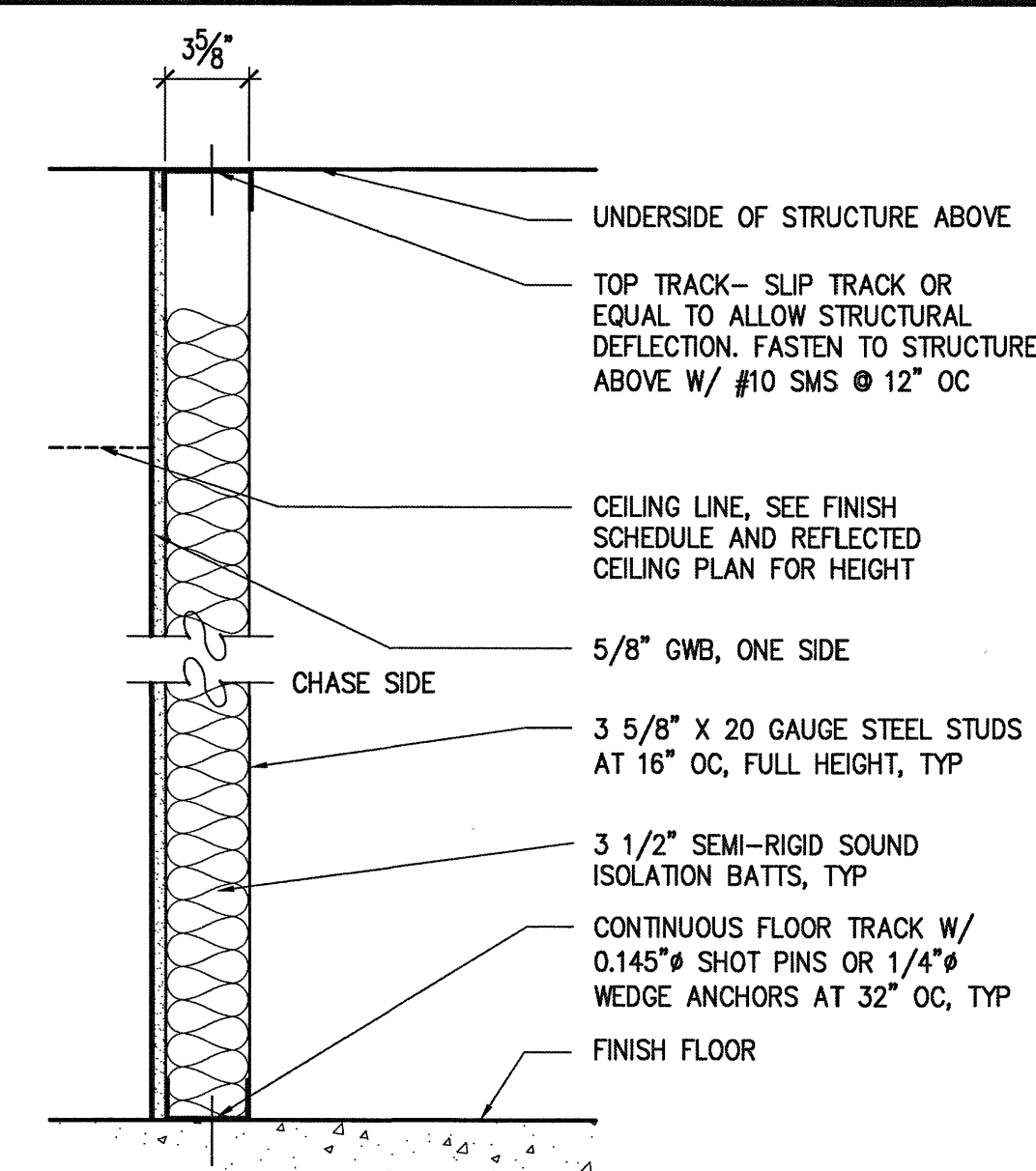

STC RATING: 30 MINIMUM

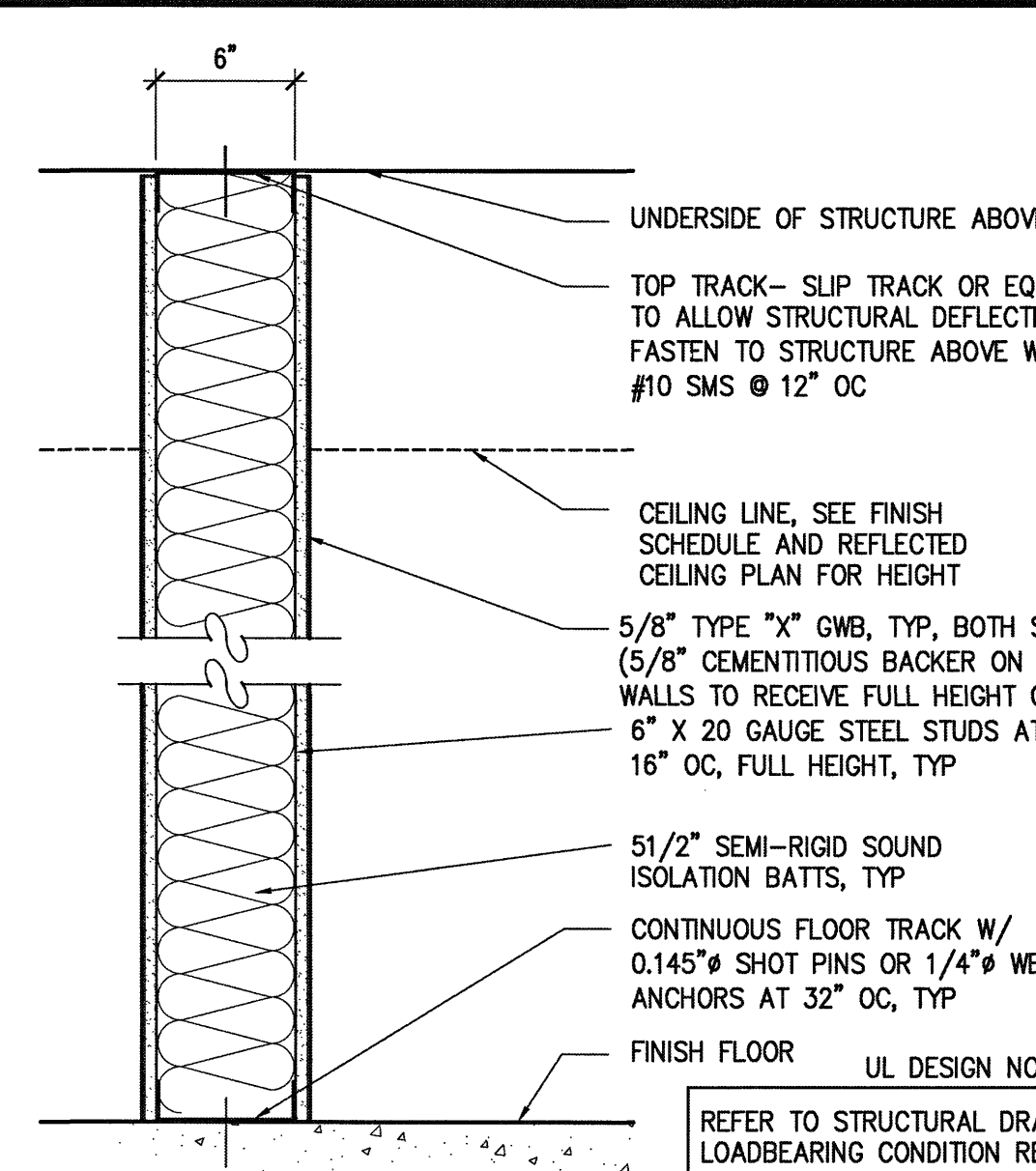

STC RATING: 45 MINIMUM

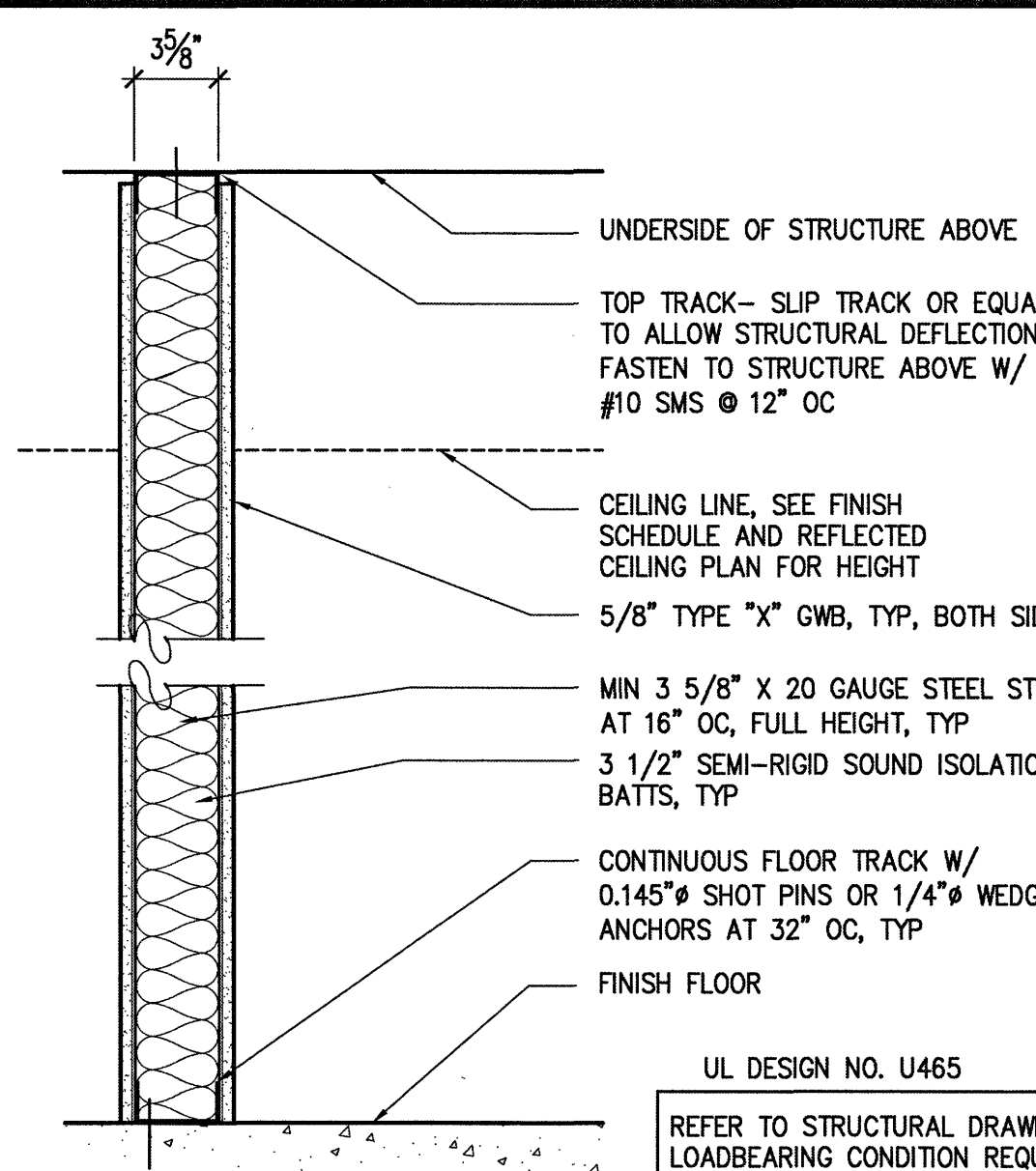

STC RATING: 45 MINIMUM

**A** 3 5/8" INTERIOR PARTITION WALL  
SCALE: 1 1/2"=1'-0"

**B** 3 5/8" CHASE WALL  
SCALE: 1 1/2"=1'-0"

**C** 6" PARTITION WALL  
SCALE: 1 1/2"=1'-0"

**D** 3 5/8" ONE-HOUR RATED PARTITION WALL  
SCALE: 1 1/2"=1'-0"

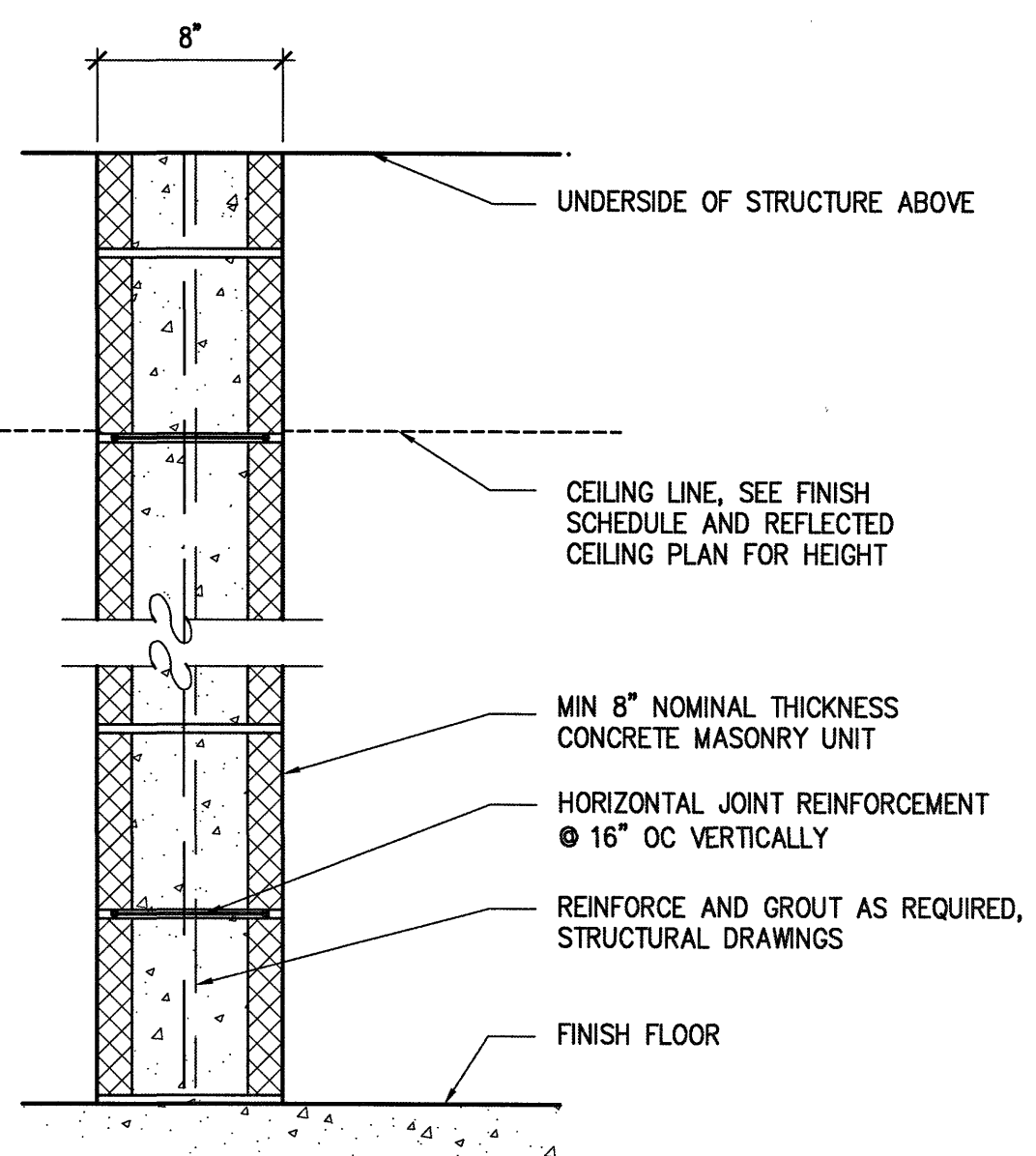

UL DESIGN U905 - 1 HOUR  
STC RATING: 45 MINIMUM

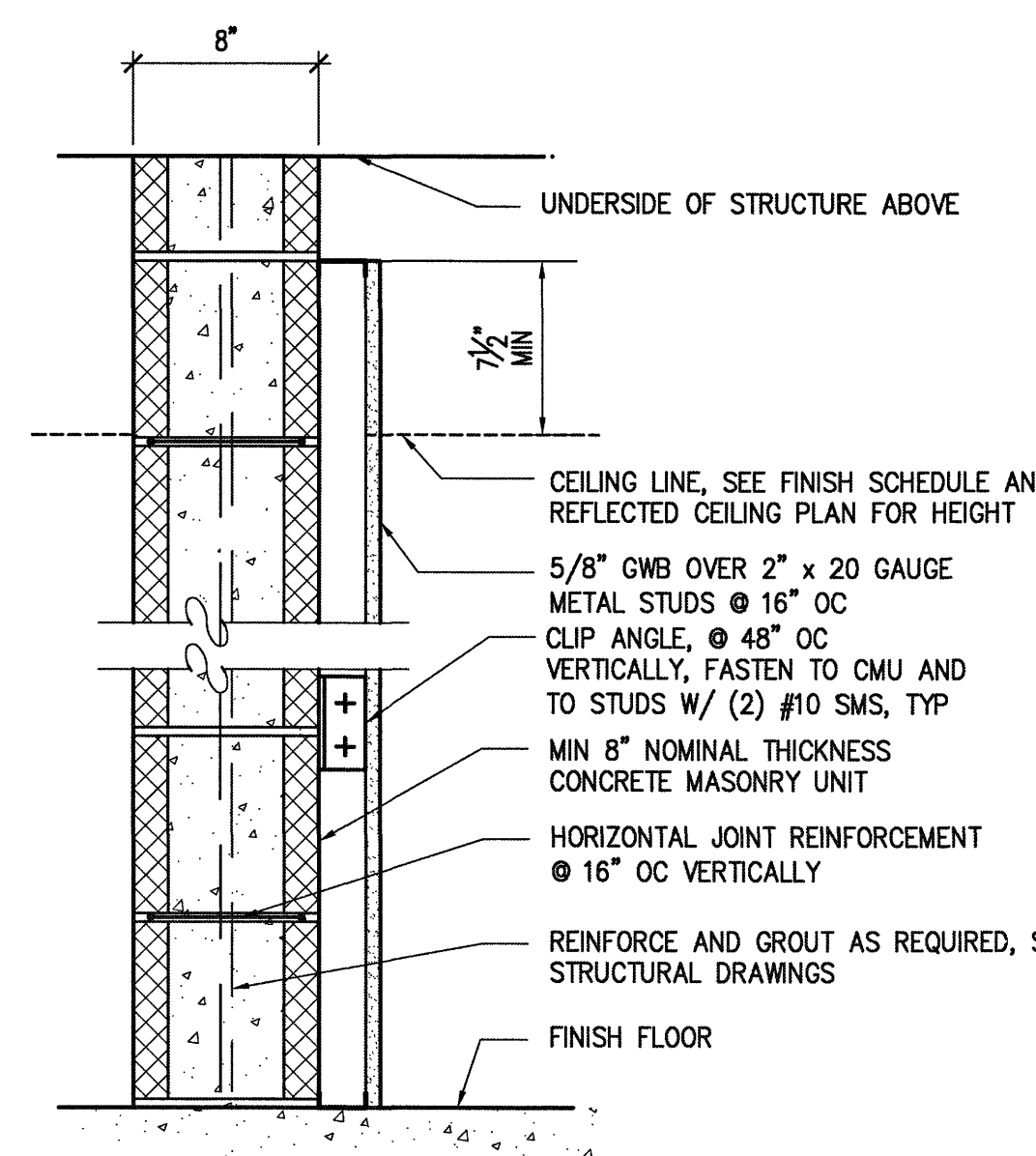

**F** 8" CMU WALL WITH 2" FURRING  
SCALE: 1 1/2"=1'-0"

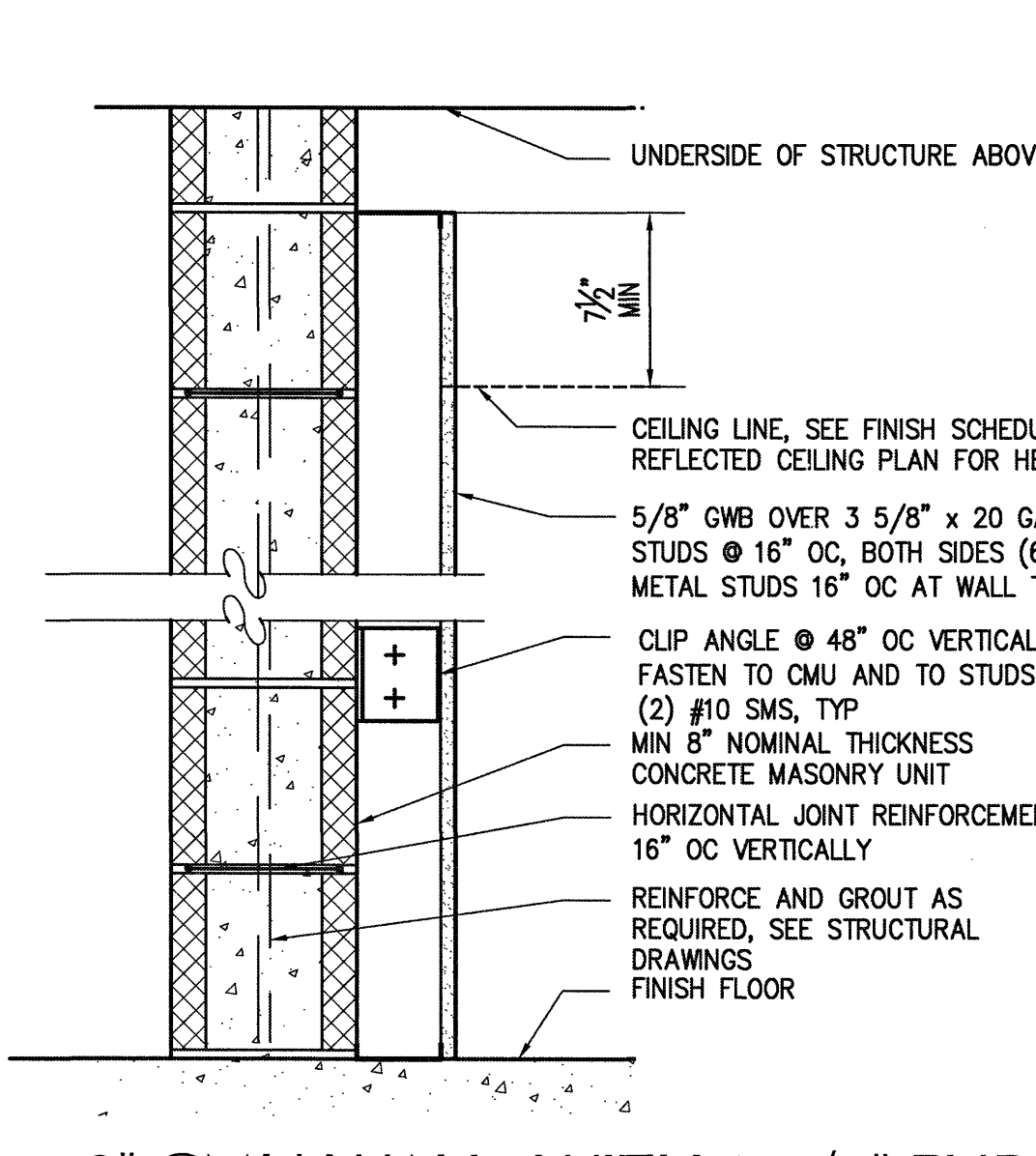

**G** 8" CMU WALL WITH 3 5/8" FURRING  
SCALE: 1 1/2"=1'-0"  
**G6** 8" CMU WALL WITH 6" FURRING  
SCALE: 1 1/2"=1'-0"

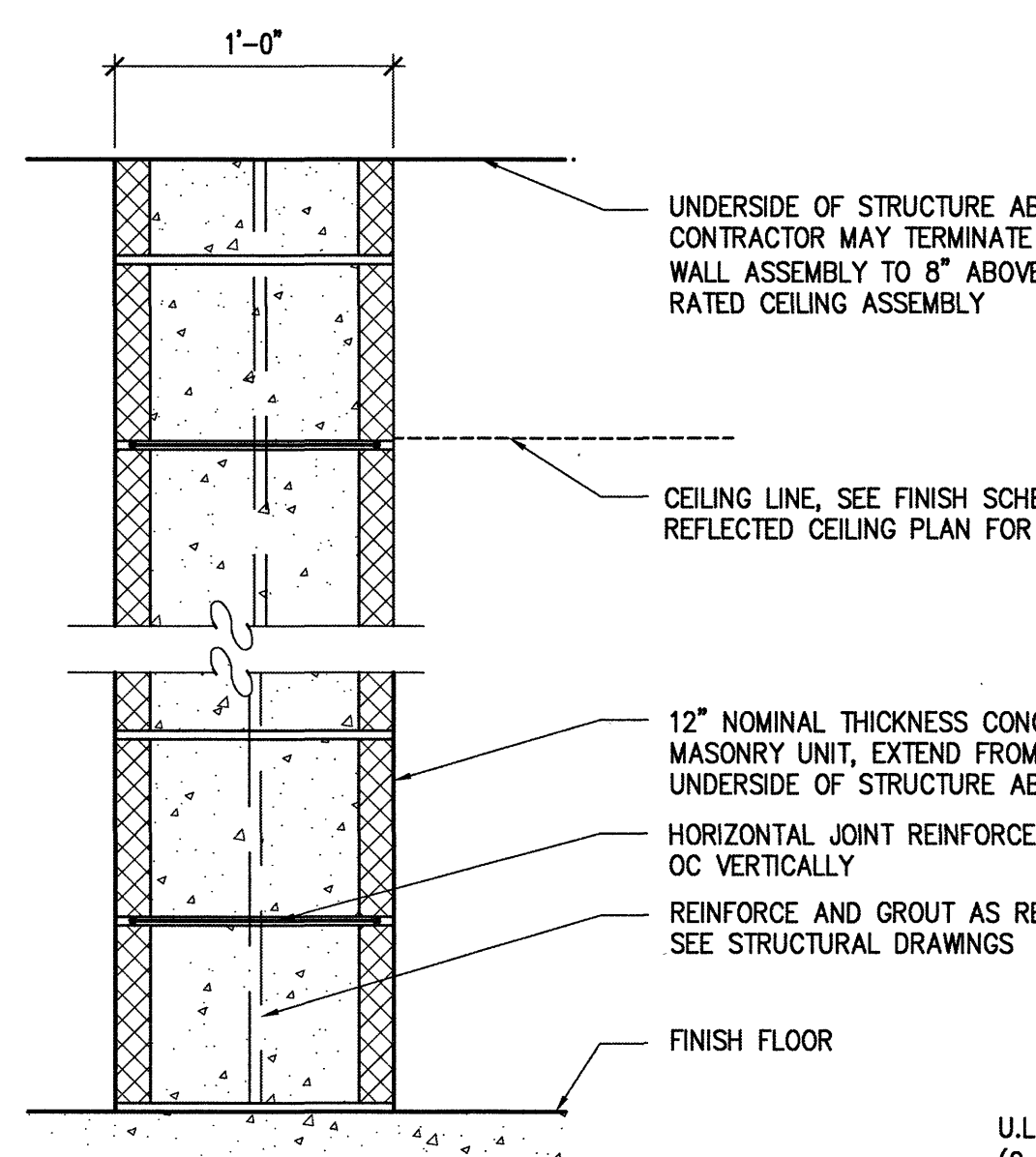

U.L. DESIGN NO. U905  
(2 HOUR MAX. RATING)  
STC RATING: 45 MINIMUM

**H** ONE HOUR RATED 12" CMU WALL  
SCALE: 1 1/2"=1'-0"

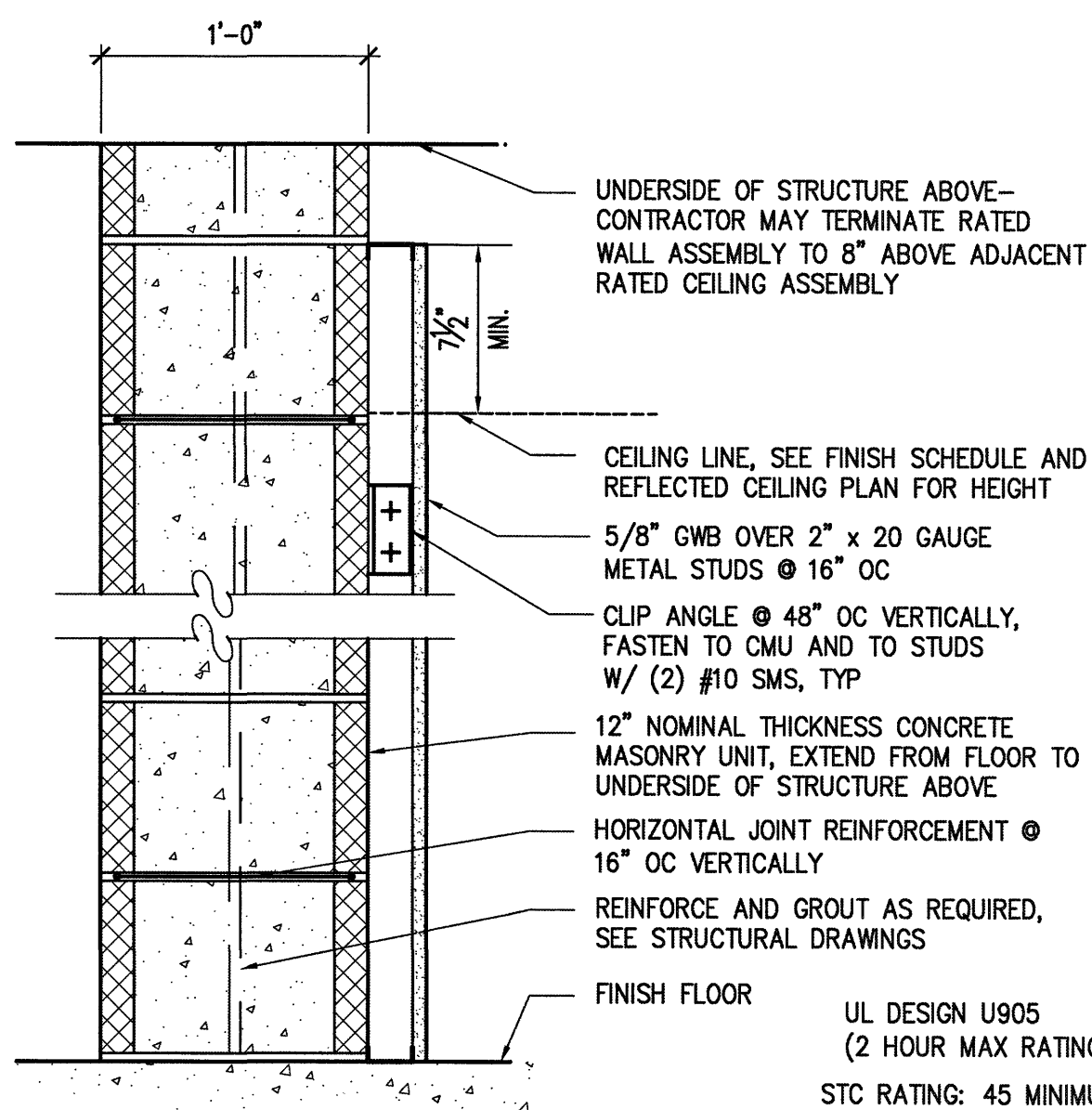

UL DESIGN U905  
(2 HOUR MAX RATING)  
STC RATING: 45 MINIMUM

**J** ONE HOUR RATED 12" CMU WALL W/ 2" FURRING  
SCALE: 1 1/2"=1'-0"

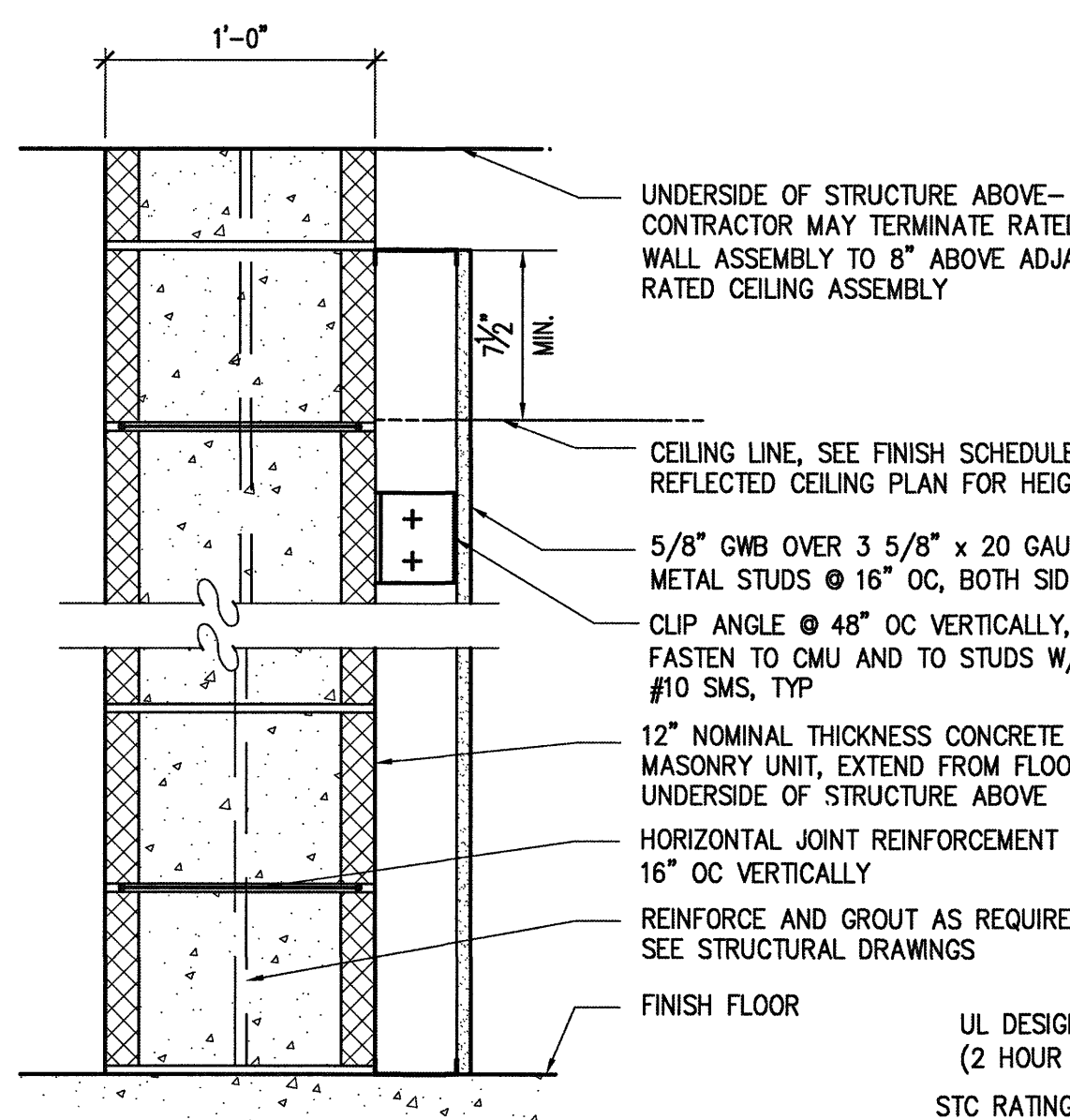

UL DESIGN U905  
(2 HOUR MAX RATING)  
STC RATING: 45 MINIMUM

**K** ONE HOUR RATED 12" CMU WALL W/ 3 5/8" FURRING  
SCALE: 1 1/2"=1'-0"

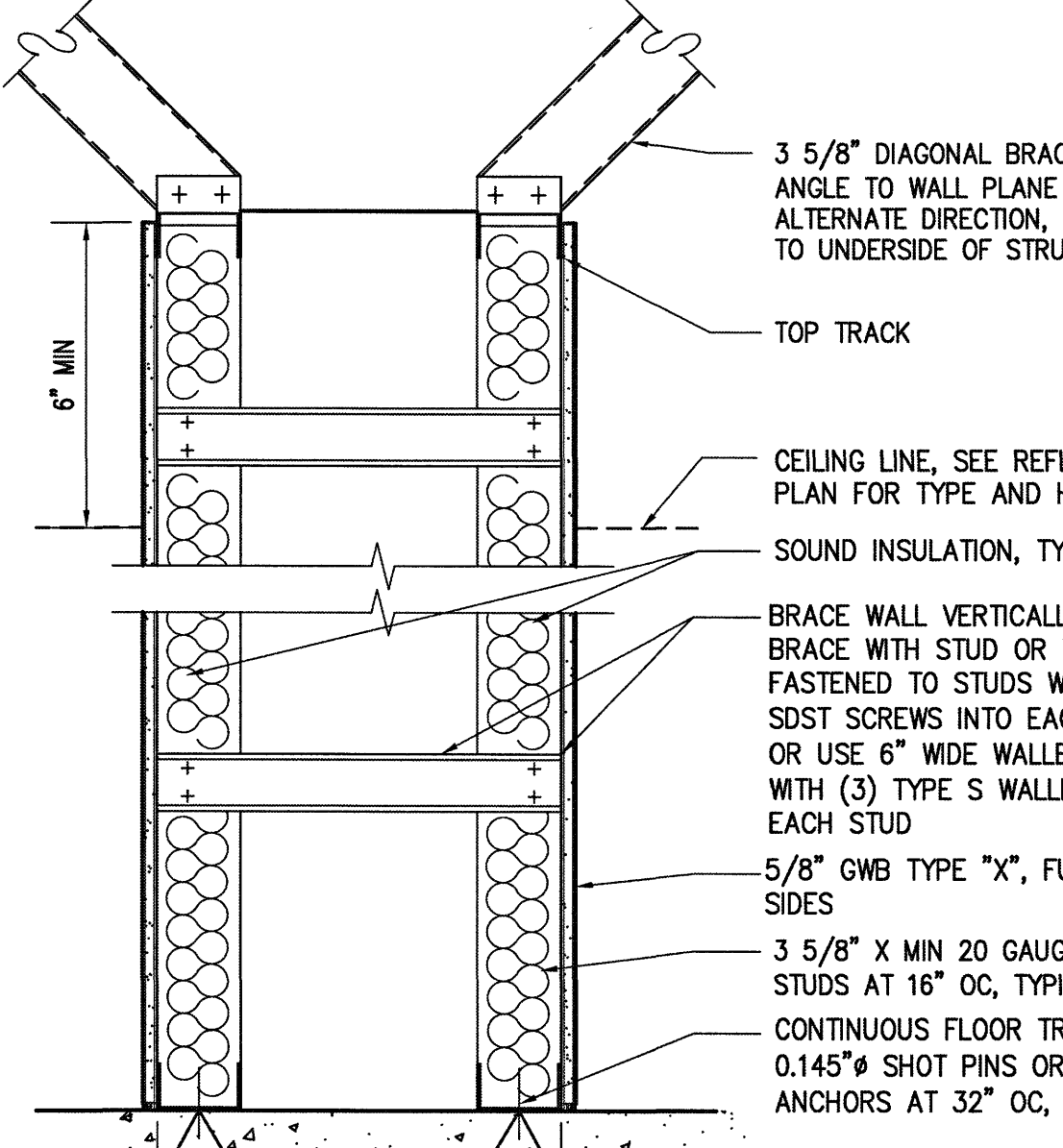

**L** CHASE WALL  
SCALE: 1 1/2"=1'-0"

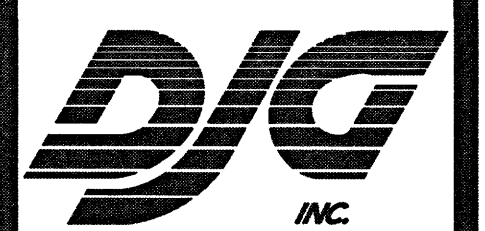
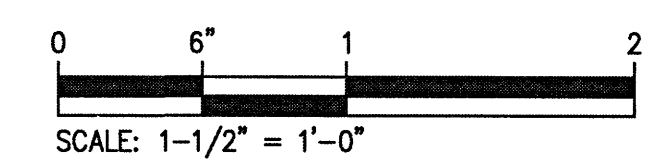

ENGINEERS  
ARCHITECTS  
PLANNERS

449 McLAWS CIRCLE  
WILLIAMSBURG, VA 23185  
(757) 253-0673 VOICE  
(757) 253-2319 FAX  
www.djginc.com



COUNTY OF ALBEMARLE

PANTOPS  
PUBLIC SAFETY  
FACILITY

IFB # 2017-11223-20

CHARLOTTESVILLE,  
VIRGINIA

REVISIONS

| NO. | DATE | DESCRIPTION |
|-----|------|-------------|
|     |      |             |
|     |      |             |
|     |      |             |
|     |      |             |
|     |      |             |
|     |      |             |
|     |      |             |
|     |      |             |
|     |      |             |
|     |      |             |

|                   |             |
|-------------------|-------------|
| DATE              | DESCRIPTION |
| COMMISSION NUMBER | 2160310     |
| SCALE:            | AS NOTED    |
| DESIGNED:         | RTL         |
| DRAWN:            | KAH         |
| CHECKED:          | DFB         |
| DATE:             | 10.28.2016  |

THE DOCUMENT CONTAINS INFORMATION PROPRIETARY TO DJG, INC. AND IS FURNISHED IN CONFIDENCE AS AN INSTRUMENT OF SERVICE FOR THE LIMITED PURPOSE OF EVALUATION, DESIGN AND REVIEW. REPRODUCTION OR CONSTRUCTION OF ANY DETAIL OR DESIGN WITHOUT THE EXPRESSED WRITTEN CONSENT OF DJG, INC. IS PROHIBITED. ALL RIGHTS RESERVED. COPYRIGHT DJG, INC. (C) 2016

SHEET TITLE

WALL TYPES

SHEET NUMBER

A-304

29 OF 68